

# Nidec

All for dreams



## *Quick Start Guide*

---

# ***Digitax HD M75X Series***

---

Variable speed AC drive  
for Servo and Induction  
motors

Part Number: 0478-0500-02

Issue: 2

# Original Instructions

For the purposes of compliance with the EU Machinery Directive 2006/42/EC.

## General information and access to additional documentation

This guide is intended to provide basic information required in order to set-up a drive to run a motor. For more detailed installation and operational information, please refer to the relevant drive documentation which is available to download from:

<http://www.drive-setup.com/ctdownloads>



## Warnings, Cautions and Notes



**WARNING**

A Warning contains information which is essential for avoiding a safety hazard.



**CAUTION**

A Caution contains information which is necessary for avoiding a risk of damage to the product or other equipment.

**NOTE**

A **Note** contains information which helps to ensure correct operation of the product.



**WARNING**

This guide does not include safety information. Incorrect installation or operation of the drive, could cause personnel injury or equipment damage. For essential safety information, please refer to the relevant drive documentation or safety booklet supplied with the drive.

---

# Contents

---

<b>1</b>	<b>Product information .....</b>	<b>8</b>
1.1	Ratings .....	8
1.2	Model number .....	8
1.3	Drive features .....	9
<b>2</b>	<b>Mechanical installation .....</b>	<b>10</b>
<b>3</b>	<b>Electrical installation .....</b>	<b>11</b>
3.1	AC supply requirements .....	11
3.2	DC supply requirements .....	11
3.3	External 24 Vdc supply .....	11
3.4	Terminal size and torque settings .....	12
<b>4</b>	<b>Getting started .....</b>	<b>13</b>
4.1	Display and Keypad operation .....	13
4.2	Quick start commissioning / start-up .....	14
4.3	Quick start commissioning / start-up using Connect .....	15
4.4	Current limits .....	17
<b>5</b>	<b>Digitax HD M75X UL Listing Information .....</b>	<b>18</b>
5.1	General .....	18
5.2	Electrical .....	19
5.3	Environmental .....	20

# EU Declaration of Conformity

**Nidec Control Techniques Ltd**

**The Gro**

**Newtown**

**Powys**

**UK**

**SY16 3BE**

This declaration is issued under the sole responsibility of the manufacturer. The object of the declaration is in conformity with the relevant European Union harmonization legislation. The declaration applies to the variable speed drive products shown below:

Model number	Interpretation	Nomenclature aaaa - bbc ddddde
aaaa	Basic series	M100, M101, M200, M201, M300, M400, M600, M700, M701, M702, M708, M709, M750, M751, M753, M754, F300, H300, E200, E300, HS30, HS70, HS71, HS72, M000, RECT
bb	Frame size	01, 02, 03, 04, 05, 06, 07, 08, 09, 10, 11
c	Voltage rating	1 = 100 V, 2 = 200 V, 4 = 400 V, 5 = 575 V, 6 = 690 V
dddd	Current rating	Example 01000 = 100 A
e	Drive format	A = 6P Rectifier + Inverter (internal choke), D = Inverter, E = 6P Rectifier + Inverter (external choke), T = 12P Rectifier + Inverter (external choke)

The model number may be followed by additional characters that do not affect the ratings.

The variable speed drive products listed above have been designed and manufactured in accordance with the following European harmonized standards:

EN 61800-5-1:2007	Adjustable speed electrical power drive systems - Part 5-1: Safety requirements - Electrical, thermal and energy
EN 61800-3: 2004+A1:2012	Adjustable speed electrical power drive systems - Part 3: EMC requirements and specific test methods
EN 61000-6-2:2005	Electromagnetic compatibility (EMC) - Part 6-2: Generic standards - Immunity for industrial environments
EN 61000-6-4: 2007+ A1:2011	Electromagnetic compatibility (EMC) - Part 6-4: Generic standards - Emission standard for industrial environments
EN 61000-3-2:2014	Electromagnetic compatibility (EMC) - Part 3-2: Limits for harmonic current emissions (equipment input current $\leq$ 16 A per phase)
EN 61000-3-3:2013	Electromagnetic compatibility (EMC) - Part 3-3: Limitation of voltage changes, voltage fluctuations and flicker in public, low voltage supply systems, for equipment with rated current $\leq$ 16 A per phase and not subject to conditional connection

EN 61000-3-2:2014 Applicable where input current < 16 A. No limits apply for professional equipment where input power  $\geq$  1 kW.

These products comply with the Restriction of Hazardous Substances Directive (2011/65/EU), the Low Voltage Directive (2014/35/EU) and the Electromagnetic Compatibility Directive (2014/30/EU).



**Jonathan Holman-White**

**Director, Technology**

**Date: 14th May 2018**

**Place: Newtown, Powys, UK**

**These electronic drive products are intended to be used with appropriate motors, controllers, electrical protection components and other equipment to form complete end products or systems. Compliance with safety and EMC regulations depends upon installing and configuring drives correctly, including using the specified input filters.**

**The drives must be installed only by professional installers who are familiar with requirements for safety and EMC. Refer to the Product Documentation. An EMC data sheet is available giving detailed information. The assembler is responsible for ensuring that the end product or system complies with all the relevant laws in the country where it is to be used.**

# EU Declaration of Conformity (including 2006 Machinery Directive)

Nidec Control Techniques Ltd

The Gro

Newtown

Powys

UK

SY16 3BE

This declaration is issued under the sole responsibility of the manufacturer. The object of the declaration is in conformity with the relevant Union harmonization legislation. The declaration applies to the variable speed drive products shown below:

Model No.	Interpretation	Nomenclature aaaa - bbc ddddde
aaaa	Basic series	M600, M700, M701, M702, M708, M709, M750, M751, M753, M754, F300, H300, E200, E300, HS70, HS71, HS72, M000, RECT
bb	Frame size	01, 02, 03, 04, 05, 06, 07, 08, 09, 10, 11
c	Voltage rating	1 = 100 V, 2 = 200 V, 4 = 400 V, 5 = 575 V, 6 = 690 V
dddd	Current rating	Example 01000 = 100 A
e	Drive format	A = 6P Rectifier + Inverter (internal choke), D = Inverter, E = 6P Rectifier + Inverter (external choke), T = 12P Rectifier + Inverter (external choke)

The model number may be followed by additional characters that do not affect the ratings.

**This declaration relates to these products when used as a safety component of a machine. Only the Safe Torque Off function may be used for a safety function of a machine. None of the other functions of the drive may be used to carry out a safety function.**

These products fulfil all the relevant provisions of the Machinery Directive 2006/42/EC and the Electromagnetic Compatibility Directive (2014/30/EU).

EC type examination has been carried out by the following notified body:

TUV Rheinland Industrie Service GmbH

Am Grauen Stein

D-51105 Köln

Germany

Notified body identification number: 0035

The harmonized standards used are shown on the following page:

EC type-examination certificate numbers:

01/205/5270.02/17 dated 2017-08-28

EN 61800-5-2:2016	Adjustable speed electrical power drive systems - Part 5-2: Safety requirements - Functional
EN 61800-5-1:2016 (in extracts)	Adjustable speed electrical power drive systems - Part 5-1: Safety requirements - Electrical, thermal and energy
EN 61800-3: 2004+A1:2012	Adjustable speed electrical power drive systems - Part 3: EMC requirements and specific test methods
EN ISO 13849-1:2015	Safety of Machinery, Safety-related parts of control systems, General principles for design
EN 62061:2005 + AC:2010 + A1:2013 + A2:2015	Safety of machinery, Functional safety of safety related electrical, electronic and programmable electronic control systems
IEC 61508 Parts 1 - 7:2010	Functional safety of electrical/ electronic/programmable electronic safety-related systems

Person authorised to complete the technical file:

P Knight

Conformity Engineer

Newtown, Powys, UK

**DoC authorised by:**



**Jonathan Holman-White**

**Director, Technology**

**Date: 14th May 2018**

**Place: Newtown, Powys, UK**

### **IMPORTANT NOTICE**

**These electronic drive products are intended to be used with appropriate motors, controllers, electrical protection components and other equipment to form complete end products or systems. It is the responsibility of the installer to ensure that the design of the complete machine, including its safety-related control system, is carried out in accordance with the requirements of the Machinery Directive and any other relevant legislation. The use of a safety-related drive in itself does not ensure the safety of the machine. Compliance with safety and EMC regulations depends upon installing and configuring drives correctly, including using the specified input filters. The drive must be installed only by professional installers who are familiar with requirements for safety and EMC. The assembler is responsible for ensuring that the end product or system complies with all relevant laws in the country where it is to be used. For more information regarding Safe Torque Off, refer to the Product Documentation.**

# 1 Product information

## 1.1 Ratings

Table 1-1 Drive ratings, cable sizes and fuse ratings

Model	No of input phases	Typical AC input current (single axis)	AC Fuse ratings (single axis)		Cable size (single axis)				Nominal current	Peak current	Typical continuous output power
					Input**		Output				
			A	IEC gG	UL Class CC, J or T*	mm <sup>2</sup>	AWG	mm <sup>2</sup>	AWG	A	A
01200022	1	3.7	8	15	0.75	14	0.75	24	1.1	6.6	0.3
01200040	1	6.9	12	15	1.5	14	0.75	22	2.2	12	0.7
01200065	1	11.4	16	15	2.5	12	0.75	20	3.5	19.5	1.1
02200090	1	17.7	25	25	4	10	0.75	16	5.6	27	1.8
02200120	1	23	32	30	6	10	0.75	16	7.5	36	2.3
03200160	1	31.5	32	40	6	8	1.5	14	10.8	48	3.4
01200022	3	5.8	8	15	0.75	14	0.75	20	2.2	6.6	0.7
01200040	3	7.9	12	15	1.5	14	0.75	18	4	12	1.3
01200065	3	10.5	16	15	2.5	14	0.75	16	6.5	19.5	2
02200090	3	16.7	25	25	4	10	1	14	9	27	2.7
02200120	3	20.3	32	30	6	10	1.5	12	12	36	3.7
03200160	3	27.9	32	40	6	8	2.5	12	16	48	5
01400015	3	3.1	6	15	0.75	14	0.75	20	1.5	4.5	0.8
01400030	3	4.8	8	15	0.75	14	0.75	20	3	9	1.6
01400042	3	5.3	8	15	0.75	14	0.75	18	4.2	12.6	1.9
02400060	3	10.1	16	25	2.5	14	0.75	16	6	18	3.1
02400080	3	12.1	16	25	2.5	12	0.75	14	8	24	4.2
02400105	3	14.9	20	25	4	12	1.5	14	10.5	31.5	3.6
03400135	3	20.8	32	30	6	10	2.5	12	13.5	40.5	6.9
03400160	3	22	32	30	6	10	2.5	12	16	48	7.6

\* These are fast acting fuses.

\*\* Short circuit rating - Input current based on a symmetrical supply fault level of 5 kA. For UL installations with a short circuit current rating greater than 5 kA refer to the *Digitax HD M75X Series Installation and Technical Guide*.

## 1.2 Model number

Figure 1-1 Model number

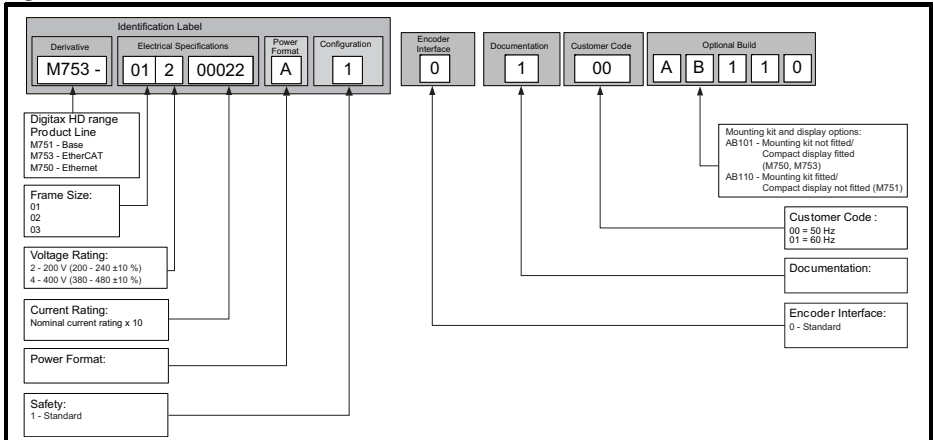



### 1.3 Drive features

Figure 1-2 Feature diagram (Frame 2 shown)

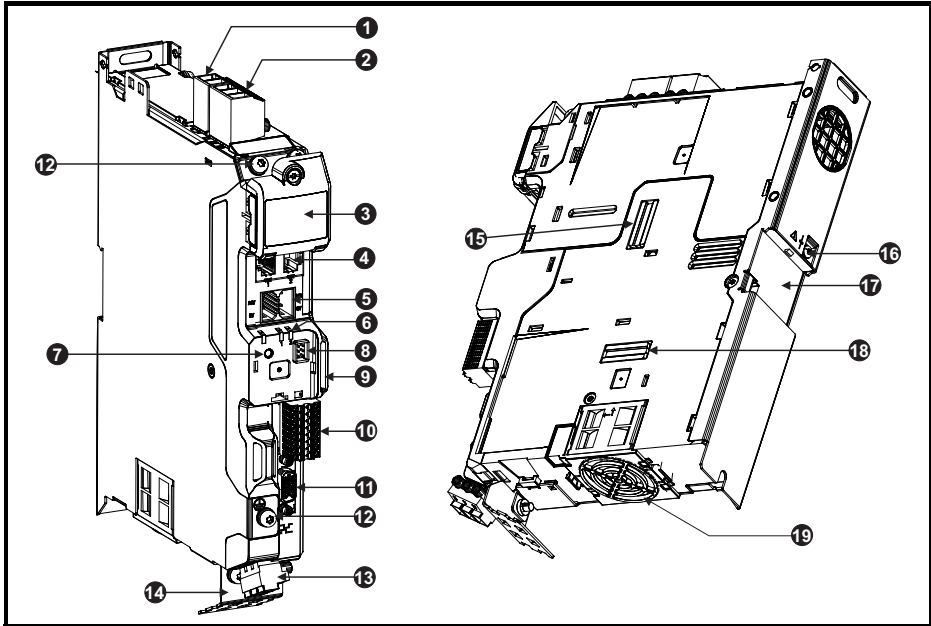

Table 1-2 Key to features of the drive

Number	Description
1	Braking terminals
2	AC supply terminals
3	DC bus terminal cover
4	Communication port connections
5	External 24 V supply terminals
6	Status and communication LEDs
7	Reset
8	Display connection
9	SD card slot
10	Control and holding brake terminals
11	Position feedback connection
12	Ground screw
13	Motor terminals
14	Cable screen bracket
15	Option module slot 1 cover*
16	Internal EMC filter screw (frame 1 and 2)
17	DIN rail alignment
18	Option module slot 2 cover*
19	Cooling fan

\* Additional SI-Option mounting kit required when connecting option modules where not already installed.

## 2 Mechanical installation

Figure 2-1 M75X dimensions (Frame 2 shown)

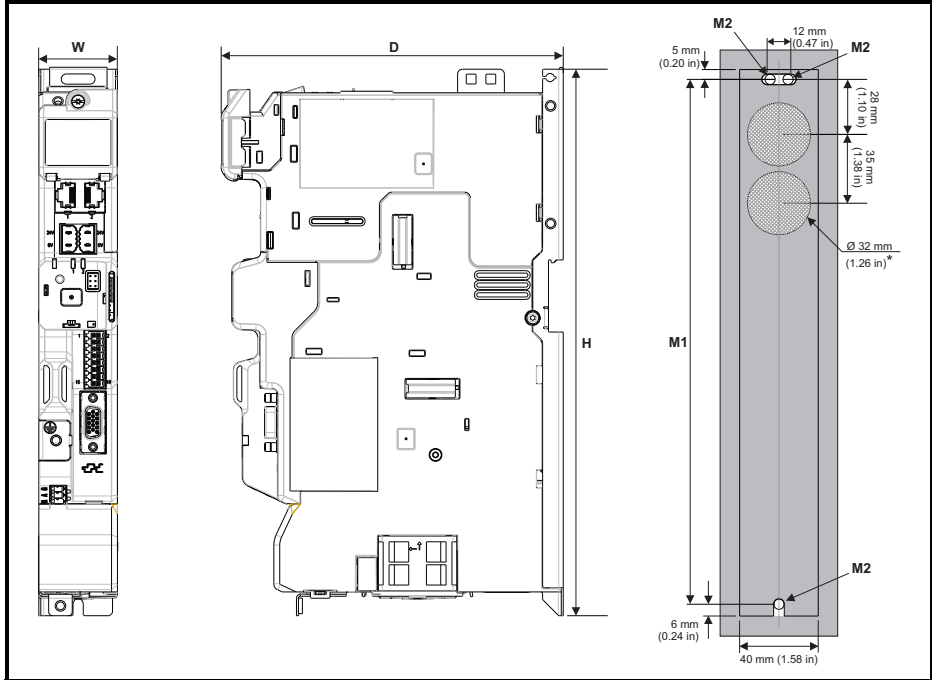

\* Cut outs only required for rear venting, refer to the *Digitax HD M75X Series Installation and Technical Guide* for further information.

Table 2-1 Dimensions by frame size (refer to Figure 2-1)

Frame size	H		W**		D		M1		M2 (Ø)*	
	mm	in	mm	in	mm	in	mm	in	mm	in
1	233	9.17	40	1.58	174	6.85	222	8.74	5.2	0.21
2	278	10.95	40	1.58	174	6.85	267	10.51	5.2	0.21
3	328	12.91	40	1.58	174	6.85	317	12.48	5.2	0.21

\* For single axis stand alone drives, two M5 screws are required in the top mounting position and one in the lower mounting position. For multi axis (side by side installation) with no DIN rail attachment, one M5 screw is required in the top mounting position and one in the lower mounting position for each drive. For multi axis (side by side installation) with DIN rail attachment one M5 screw in the top mounting position is sufficient to fix the drive to the back plate.

\*\* 62 mm (2.44 in) with option module support installed.

### NOTE

- All frame sizes require a minimum clearance of 100 mm (3.94 in) above and below the product.
- A minimum clearance of 10 mm (0.39 in) should be maintained between the enclosure side wall and the drive.

Drives may be mounted side by side (0 mm). For further information on mechanical installation refer to the *Digitax HD M75X Series Installation and Technical Guide*.

## 3 Electrical installation

An overlay of the electrical connections / terminals is included on the back page of this manual.

### 3.1 AC supply requirements

**Table 3-1 Supply requirements**

Model	Voltage	Frequency range
Digitax HD M75X 200 V	200 V to 240 V $\pm 10$ % single phase	45 to 66 Hz
Digitax HD M75X 200 V	200 V to 240 V $\pm 10$ % three phase*	45 to 66 Hz
Digitax HD M75X 400 V	380 V to 480 V $\pm 10$ % three phase*	45 to 66 Hz

\* Maximum supply imbalance: 2 % negative phase sequence (equivalent to 3 % voltage imbalance between phases).

The supply and motor ground connections are made using the M4 threaded holes in the metal side plate of the drive. Connections are located at the top and bottom of the drive, for further information refer to the *Digitax HD M75X Series Installation and Technical Guide*.

For EMC (Electromagnetic compatibility) requirements refer to the *Digitax HD M75X Series Installation and Technical Guide*.

### 3.2 DC supply requirements

The drive is able to operate from a DC supply with a range from 24 Vdc to the maximum DC volts.

The working voltage range of the low voltage DC power supply is as follows:

Minimum continuous operating voltage:	26 V
Minimum start up voltage:	32 V
Maximum over voltage trip threshold:	230 V drives: 415 V 400 V drives: 830 V

### 3.3 External 24 Vdc supply

 <b>WARNING</b>	The drive will power down and reset if the external 24 Vdc is removed.
--	--

An external 24 Vdc supply is required to power all the low voltage circuits within the drive.

The working voltage range of the drive 24 V power circuit is as follow:

**Table 3-2 Working voltage range of the 24 Vdc supply**

All frame sizes	
Nominal operating voltage	24.0 Vdc
Minimum continuous operating voltage	20.4 V
Maximum continuous operating voltage	28.8 V
Minimum start up voltage	20.4 V
Maximum fuse rating	30 A

### 3.4 Terminal size and torque settings

Table 3-3 Drive terminal data

Terminal description	Max cable size	Min cable size	Recommended torque	Tool
AC power terminal connector	6 mm <sup>2</sup> (8 AWG)	0.5 mm <sup>2</sup> (20 AWG)	0.7 N m (6.2 lb in)	2.5 mm flat blade screwdriver
Motor power terminal connector	4 mm <sup>2</sup> (8 AWG)	0.5 mm <sup>2</sup> (20 AWG)	0.5 N m (4.4 lb in)	
Brake terminal connector	6 mm <sup>2</sup> (8 AWG)	0.5 mm <sup>2</sup> (20 AWG)	0.7 N m (6.2 lb in)	
Control terminal	1.5 mm <sup>2</sup> (16 AWG)	0.2 mm <sup>2</sup> (24 AWG)		
+24 V supply connector	6 mm <sup>2</sup> (8 AWG)	0.5 mm <sup>2</sup> (20 AWG)	0.5 N m (4.4 lb in)	
DC busbar			2 N m (17.7 lb in)	T20 Torx screwdriver
Ground busbar			2 N m (17.7 lb in)	
<b>Optional</b>				
Internal EMC filter screw			0.8 N m (7.1 lb in)	T10 Torx screwdriver
Compact brake resistor mounting screw			0.8 N m (7.1 lb in)	T10 Torx screwdriver
Compact brake resistor thermistor screw			0.3 N m (2.7 lb in)	2.5 mm flat blade screwdriver

# 4 Getting started



## 4.1 Display and Keypad operation

The drive can be operated with a KI-Compact Display or KI-Remote Keypad RTC.

Only the KI-Remote Keypad RTC can be used to view and edit parameters. Connection to the drive can be established via a KI-Compact 485 Adaptor (all M75X variants) or via a drive communication port (M751 only) and a suitable Cat 5E patch cord.

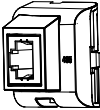

Refer to the relevant *Digitax HD M75X Control User Guide* for information on the installation and operation of the KI-Compact Display, KI-Compact 485 Adaptor and KI-Remote Keypad RTC.

**Table 4-1 Display / Keypad identification**

Type	Keypad	Name	Further Details
Display		KI-Compact Display	<b>Single segment display option</b> Compact display with single character code drive status representation, node address setting and a push button reset
Accessory		KI-Compact 485 Adaptor	<b>KI-Compact 485 Adaptor</b> The KI-Compact 485 Adaptor provides an EIA-485 port for permanent connection to a KI-Remote Keypad RTC or the temporary attachment for PC tool connection
Keypad		Remote-Keypad RTC	<b>Remote LCD keypad option</b> Remote Keypad with a LCD display and a real time clock

## 4.2 Quick start commissioning / start-up

Action	User drive mode*	Detail
Before power-up	All	Ensure: <ul style="list-style-type: none"> <li>• The drive enable signal is not given (terminal 2 &amp; 6)</li> <li>• Run signal is not given</li> <li>• Run signal is not given</li> <li>• Motor and feedback device are connected</li> </ul>
Power-up the drive	All	Verify that the required user drive mode is displayed on the KI-Remote Keypad RTC as the drive powers up. If the mode is incorrect refer to the relevant <i>Digitax HD M75X Control User Guide</i> on how to change the drive mode. Ensure: <ul style="list-style-type: none"> <li>• Drive displays 'Inhibit'</li> </ul> If the drive trips refer to the diagnostics section of the relevant <i>Digitax HD M75X Control User Guide</i> .
Set motor feedback parameters**	RFC-S (with feedback) RFC-A (with feedback)	<p><b>Incremental encoder basic set-up</b></p> <p>Enter:</p> <ul style="list-style-type: none"> <li>• Drive encoder type in Pr <b>03.038</b> = AB Servo (3) Quadrature encoder with commutation outputs</li> <li>• Encoder power supply in Pr <b>03.036</b> = 5 V (0), 8 V (1) or 15 V (2).</li> </ul> <p><b>NOTE</b></p> <p>If output voltage from the encoder is &gt; 5 V, then the termination resistors must be disabled Pr <b>03.039</b> to 0.</p> <div style="border: 1px solid black; padding: 5px; margin: 10px 0;">  <p>Setting the encoder voltage supply too high for the encoder could result in damage to the feedback device.</p> <p><b>CAUTION</b></p> </div> <ul style="list-style-type: none"> <li>• Drive encoder Lines Per Revolution (LPR) in Pr <b>03.034</b> (set according to encoder)</li> <li>• Drive encoder termination resistor setting in Pr <b>03.039</b>:  <b>0</b> = A-A\, B-B\, Z-Z\ termination resistors disabled  <b>1</b> = A-A\, B-B\, termination resistors enabled, Z-Z\ termination resistors disabled  <b>2</b> = A-A\, B-B\, Z-Z\ termination resistors enabled</li> </ul>
Enter motor nameplate details	All	Enter: <ul style="list-style-type: none"> <li>• Motor rated current in Pr <b>00.046</b> (A)</li> <li>• Number of poles in Pr <b>00.042 (RFC-S only)</b></li> <li>• Motor rated frequency in Pr <b>00.047</b> (Hz) (RFC- A &amp; open loop only)</li> <li>• Motor rated speed in Pr <b>00.045</b> (rpm) (RFC- A &amp; open loop only)</li> <li>• Motor rated voltage in Pr <b>00.044</b> (V)</li> </ul>
Set maximum speed	All	Enter: <ul style="list-style-type: none"> <li>• Maximum speed in Pr <b>00.002</b> (rpm)</li> </ul>
Set acceleration / deceleration rates	All	Enter: <ul style="list-style-type: none"> <li>• Acceleration rate in Pr <b>00.003</b> (s/100 Hz open loop or s/1000 rpm RFC-A/ RFC-S).</li> <li>• Deceleration rate in Pr <b>00.004</b> (s/100 Hz open loop) or s/1000 rpm RFC-A/ RFC-S).</li> <li>• If braking resistor installed, set Pr <b>00.015</b> = Fast. Also ensure Pr <b>10.S30</b>, Pr <b>10.031</b> and Pr <b>10.061</b> are set correctly, otherwise premature 'Brake R Too Hot' trips may be seen.</li> </ul>

Action	User drive mode*	Detail
Autotune	All	<p>The drive is able to perform either a stationary or a rotating autotune. The motor must be at a standstill before an autotune is enabled. A stationary autotune will give moderate performance whereas a rotating autotune will give improved performance as it measures the actual values of the motor parameters required by the drive. Refer to the relevant <i>Digitax HD M75X Control User Guide</i> for more information on the autotune function.</p> <div style="border: 1px solid black; padding: 5px;">  <p><b>Open loop and RFC-A mode</b> A rotating autotune will cause the motor to accelerate up to 2/3 base speed in the direction selected regardless of the reference provided. Once complete the motor will coast to a stop.</p> <p><b>WARNING RFC-S drive mode</b> The rotating autotune will rotate the motor up to 2 mechanical revolutions in the direction selected, regardless of the reference provided. After a short delay, the motor is further rotated through an electrical revolution. The enable signal must be removed before the drive can be made to run at the required revolution.</p> <p>The enable signal must be removed before the drive can be made to run at the required reference. The drive can be stopped at any time by removing the run signal or removing the drive enable.</p> </div> <p>To perform an autotune:</p> <ul style="list-style-type: none"> <li>• Set Pr <b>00.040</b> = 1 for a stationary autotune, Pr <b>00.040</b> = 2 for a rotating autotune.</li> <li>• Close the run signal (terminal 11 or 13).</li> <li>• Close the drive enable signal (terminal 2 &amp; 6).</li> </ul> <p>The upper row of the display will flash 'Auto Tune' while the drive is performing the test.</p> <ul style="list-style-type: none"> <li>• Wait for the drive to display 'Ready' or 'Inhibit' and for the motor to come to a standstill.</li> </ul> <p>If the drive trips it cannot be reset until the drive enable signal (terminal 2 &amp; 6) has been removed.</p> <p>Refer to the diagnostics chapter of the relevant <i>Digitax HD M75X Control User Guide</i>.</p> <ul style="list-style-type: none"> <li>• Remove the drive enabled and run signal from the drive.</li> </ul>
Save parameters	All	Select 'Save Parameters' in Pr <b>MM.000</b> (alternatively enter a value of 1001 in Pr <b>MM.000</b> ) and press red reset button  or toggle the reset digital input.
Run	All	Drive is now ready to run.

\* The Digitax HD M75X series are factory configured in RFC-S mode.

\*\* For simplicity only an incremental quadrature encoder with commutation outputs are considered here. For more information on setting up one of the other supported feedback devices, refer to the relevant *Digitax HD M75X Control User Guide*.

### 4.3 Quick start commissioning / start-up using Connect

Connect is a Windows™ based software commissioning / start-up tool for Digitax HD.

Connect can be downloaded from <http://www.drive-setup.com/ctdownloads>

#### Connect system requirements

- Windows 8, Windows 7 SP1, Windows Vista SP2, Windows XP SP3
- Minimum of 1280 x 1024 screen resolution with 256 colours
- Microsoft.Net Frameworks 4.0 (this is provided in the downloaded file)
- Note that you must have administrator rights to install Connect

Any previous copy of Connect should be uninstalled before proceeding with the installation (existing projects will not be lost).

### 4.3.1 Power-up the drive

Start Connect, and on the 'Project Management' screen select 'Scan serial RTU network' (M751 only when connected to the drive communication port or all variants when connecting via the KI-Compact 485 Adaptor), 'Scan Ethernet network' (M750 only or M753 when using Ethernet over EtherCAT protocol) or 'Scan all connected drives'. This example uses the 'Scan serial RTU network' option.

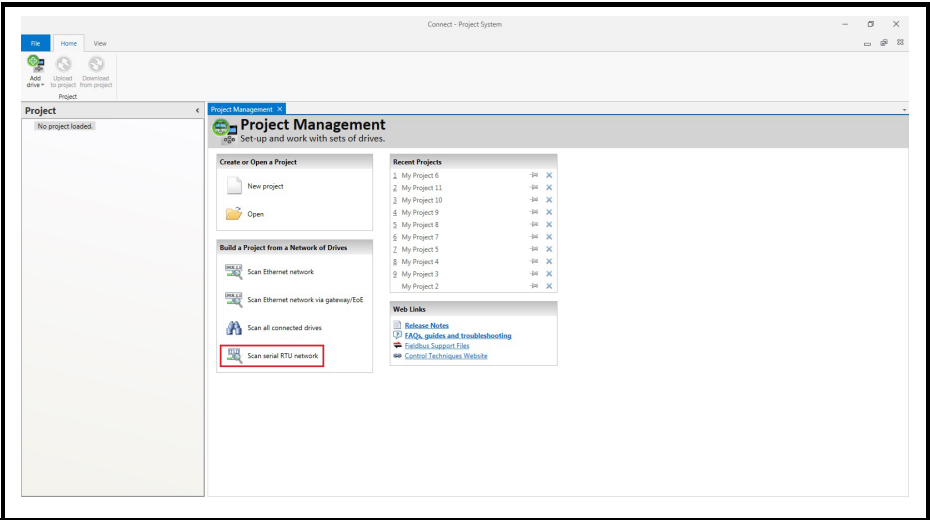

Select the discovered drive.

1. Select the 'Online' icon to connect with the drive. When a successful connection is made the icon will be highlighted blue.

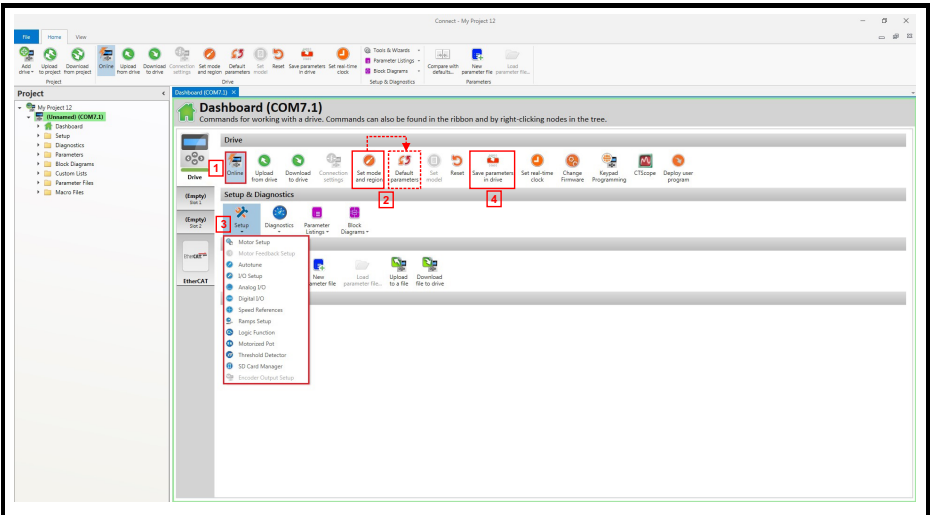

2. Select 'Set mode and region'.

If the required control mode is highlighted in the 'Drive Settings' dialog, then:

- Change the supply frequency, if required and select 'Apply', otherwise select 'Cancel'.



- Select 'Default parameters' from the Dashboard and in the 'Default Parameters' dialog, select 'Apply'.
- If the required control mode is not highlighted in the 'Drive Settings' dialog then:
  - Select the required mode and supply frequency.
  - Select 'Apply'.

3. Select 'Setup' and perform the steps highlighted:

Action	Detail
Motor Set-up	Connect contains a database for induction motors and permanent magnet motors. Provision is also made to enter motor nameplate data.
Motor Feedback Set-up	<p>This only needs to be performed in RFC-S and RFC-A (with feedback) modes. Enter the encoder type and encoder configuration data as prompted on screen.</p> <p><b>NOTE</b> If output voltage from the encoder is &gt; 5 V, then the termination resistors must be disabled Pr <b>03.039</b> to 0.</p> <div style="border: 1px solid black; padding: 5px;">  <p>Setting the encoder voltage supply too high for the encoder could result in damage to the feedback device.</p> <p><b>CAUTION</b></p> </div>
Speed References	Enter preset speeds or a jog reference if required.
Ramps Set-up	Enter the required Acceleration rate and Deceleration rate. Note: If a braking resistor is installed, set 'Ramp mode' to 'Fast'. Also ensure Pr <b>10.030</b> and Pr <b>10.031</b> and Pr <b>10.061</b> are set correctly, otherwise premature 'Brake R Too Hot' trips may be seen.
I/O Setup	Map I/O terminals to parameters (where non default configuration is required).
Analog I/O	Configure Analog input 1 and thermal monitoring parameters (where non default configuration is required).
Digital I/O	Allocate non default digital control functions to digital terminals where necessary.
Autotune	Follow the Autotune set up wizard to automatically tune the drive to the motor. <b>NOTE</b> Not required when using data from the motor database for a Leroy Somer LSRPM motor used in RFC-S Sensorless mode.

4. Select 'Save parameters in drive' to perform a parameter save.

The drive is now ready to run.

## 4.4 Current limits

The default setting for the current limit parameters is:

- 165 % x motor rated torque producing current for open loop mode
- 250 % x motor rated torque producing current for RFC-A and RFC-S modes.

There are three parameters which control the current limits:

- Pr **04.005** *Motoring Current Limit*: power flowing from the drive to the motor
- Pr **04.006** *Regen Current Limit*: power flowing from the motor to the drive
- Pr **04.007** *Symmetrical Current Limit*: current limit for both motoring and regen operation

The lowest of either the motoring and regen current limit, or the symmetrical current limit applies.

The maximum setting of these parameters depends on the values of motor rated current, drive rated current and the power factor. The drive can be oversized to permit a higher current limit setting to provide higher accelerating torque as required up to a maximum of 1000 %.

# 5 Digitax HD M75X UL Listing Information

This section is intended to be used in conjunction with the *Digitax HD M75X Series Installation and Technical Guide*.

## 5.1 General

### 5.1.1 Scope

All models are cUL Listed to Canadian and US requirements.

The UL file reference is: NMMS / 7. E171230.

### 5.1.2 Applicant and Listee

Nidec Control Techniques Ltd

The Gro

Pool Road

Newtown

Powys

SY16 3BE

UK.

### 5.1.3 Manufacturer

Products are manufactured at several sites worldwide.

Primary manufacturing site:

Nidec Industrial Automation UK Ltd

Unit 79

Mochdre Industrial Estate

Newtown

Powys

SY16 4LE

UK.

The Manufacturing Location Code is: 8D14

### 5.1.4 Model numbers

The model numbers are shown in section 1.1 *Ratings*.

### 5.1.5 Safety information

Important safety information is included with the safety booklet supplied with the drive.

### 5.1.6 Adjustments

The *Digitax HD M75X Series Installation and Technical Guide* gives details of all safety-relevant adjustments intended for the user. The identification or function of each control or indicating device and fuse is clearly marked in the diagrams in the *Digitax HD M75X Series Installation and Technical Guide*.

Maintenance adjustments are also described in the *Digitax HD M75X Series Installation and Technical Guide*. They should only be made by qualified personnel. Clear warnings are provided where excessive adjustment could lead to a hazardous state of the Power Drive System (PDS), Complete Drive Module (CDM) or Basic Drive Module (BDM). Any special equipment necessary for making adjustments is specified and described in 'Mechanical installation' (Chapter 3) of the *Digitax HD M75X Series Installation and Technical Guide*.

## **5.2 Electrical**

### **5.2.1 Ratings**

The electrical ratings are shown in section 1.1 *Ratings* on page 8.

### **5.2.2 Short circuit current rating**

All drives:

5 kA when protected by Listed fuses as specified in the *Digitax HD M75X Series Installation and Technical Guide*.

100 kA when protected by recognised supplemental fuses as specified in the *Digitax HD M75X Series Installation and Technical Guide*.

### **5.2.3 Overvoltage category**

The Over Voltage Category is OVC III.

OVC III applies to equipment permanently connected in fixed installations (Downstream of and including the main distribution board).

### **5.2.4 Input current, fuse ratings and cable sizes**

Electrical installation shall be in accordance with the US National Electrical Code, the Canadian Electrical Code and any additional local codes, as required.

The ground (earth) connections and the DC power connections must use UL Listed ring terminals sized according to the field wiring. Only one cable is permitted to be connected to each field wiring terminal.

The recommended cable sizes and fuse ratings are shown in section 1.1 *Ratings* on page 8.

Drives must be installed using cables rated for 75 °C operation, copper wire only.

Opening of the branch-circuit protective device may be an indication that a fault has been interrupted. To reduce the risk of fire or electric shock, the equipment should be examined and replaced if damaged. If burnout of the current element of an overload relay occurs, the complete overload relay must be replaced.

Integral solid state short circuit protection does not provide branch circuit protection. Branch circuit protection must be provided in accordance with the National Electrical Code (NEC), The Canadian Electrical Code, and any additional local codes.

### **5.2.5 Motor cable size and maximum length**

The recommended motor cable sizes and maximum length are shown in section 1.1 *Ratings* on page 8.

### **5.2.6 Multiple wiring arrangements**

The drives are able to operate from either a single phase or a three-phase AC supply.

Additionally, the drives are able to operate from a DC supply with a range from 24 Vdc up to the maximum rated DC supply voltage. It is possible for the drive to go from operating on a normal line power supply voltage to operating on a much lower supply voltage without interruption. The wiring arrangements are shown in the 'Electrical installation' (Chapter 4) of the *Digitax HD M75X Series Installation and Technical Guide*.

### **5.2.7 External 24 V supply**

An external 24 Vdc supply is required to power the low voltage circuits within the drive. The low voltage circuits are isolated from the live circuits. The 24 V supply must be protected by a supplemental fuse. Refer to the 'Electrical installation' (Chapter 4) of the *Digitax HD M75X Series Installation and Technical Guide*.

### **5.2.8 Common DC bus systems**

Multiple drives can be connected together via a common DC bus. For further details, refer to 'Multi axis system design' (Chapter 5) of the *Digitax HD M75X Series Installation and Technical Guide*.

## 5.2.9 Solid state short circuit protection

Integral solid state short circuit protection is provided. However, this does not provide branch circuit protection.

In the event of a ground (earth) fault within the drive, the input protective devices (fuses or circuit breaker) provide overcurrent protection in the usual way. All AC drives incorporate solid state short circuit protection. If a ground (earth) fault occurs in the motor circuit, the solid-state protection operates, the inverter trips and all power switches (IGBTs) are switched off within a very short time, typically less than 10  $\mu$ s. The total trip time is unlikely to exceed 100  $\mu$ s. In the event of failure of the solid state short circuit protection, one or more of the inverter power devices then fails either open or short circuit. If the failure mode is open-circuit, the fault is interrupted. If the failure mode is short-circuit, the input protection devices (fuses or circuit breaker) clear the fault and open the circuit.

## 5.2.10 Motor overload protection and thermal memory retention

All drives incorporate internal overload protection for the motor load that does not require the use of an external or remote overload protection device. The method of adjustment of the overload protection is provided in section 4.4 *Current limits* on page 17. The protection levels are expressed as a percentage of full load current. In order for the motor protection to work properly, the motor rated current must be entered into Pr **00.046** or Pr **05.007**. The motor overload protection levels may be adjusted below 250 % (RFC-S/RFC-A) or 165 % (Open loop) if required. The duration of the overload is dependent on motor thermal time constant. The drives are provided with user terminals that can be connected to a motor thermistor to protect the motor from high temperature, in the event of a motor cooling fan failure.

## 5.3 Environmental

### 5.3.1 Enclosure rating

All drives are Open Type.

### 5.3.2 Mounting

Drives may be mounted

- Singly
- Side by side
- Stacked one above another when fitted with a rear vent kit

The drives are equipped with a rear vent that allows heated air to be exhausted from the rear of the drive rather than the through the top. This mounting arrangement provides the following benefits:

- Reduction in enclosure size.
- Allow vertical stacking of drives.
- Reduce the need for a secondary enclosure fan.

Refer to the 'Mechanical Installation' (Chapter 3) of the *Digitax HD M75X Series Installation and Technical Guide*.

For compact multi axis installations, the rear venting kit allows drives to be vertically mounted one above the other, where this is the case, a minimum clearance of 100 mm (3.94 in) should be maintained between drives. A current derating must be applied to the drive if the rear vent kit is installed. Derating information is provided in the 'Technical Data' (Chapter 6) of the *Digitax HD M75X Series Installation and Technical Guide*. Failure to do so may result in nuisance tripping.

### 5.3.3 Operating temperature

The drives are suitable for use up to 40 °C (104 °F) surrounding air temperature. Operation up to 55 °C (131 °F) is permitted with de-rated output. Refer to the 'Technical Data' (Chapter 6) of the *Digitax HD M75X Series Installation and Technical Guide*.

### **5.3.4 Pollution degree**

Drives are designed for operation in a pollution degree 2 environment or better (dry, non-conductive pollution only).

### **5.3.5 Plenum rating**

The drives are not suitable for installation in a compartment (duct) handling conditioned air.

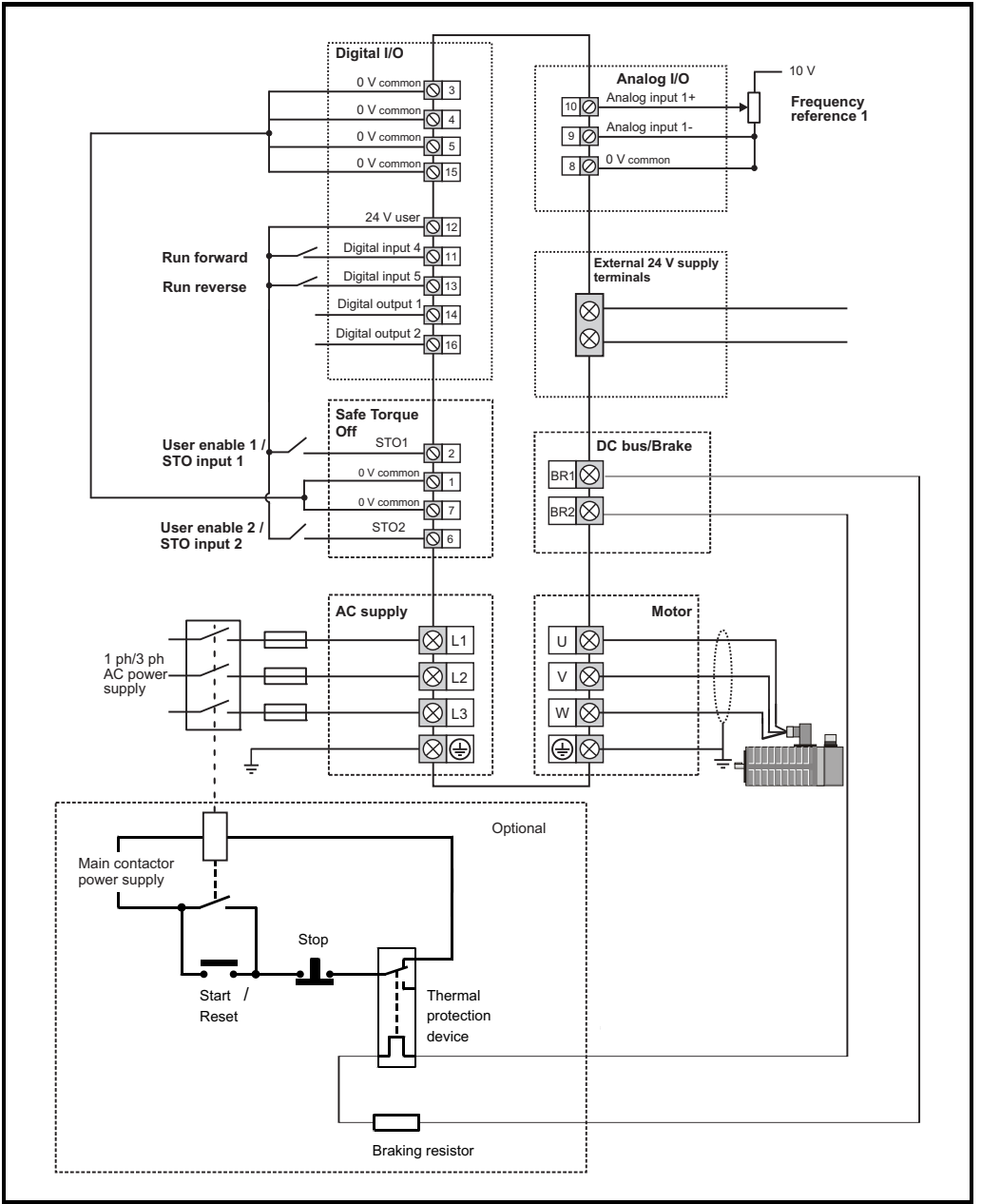

0478-0500-02